

LEFT SIDE VIEW

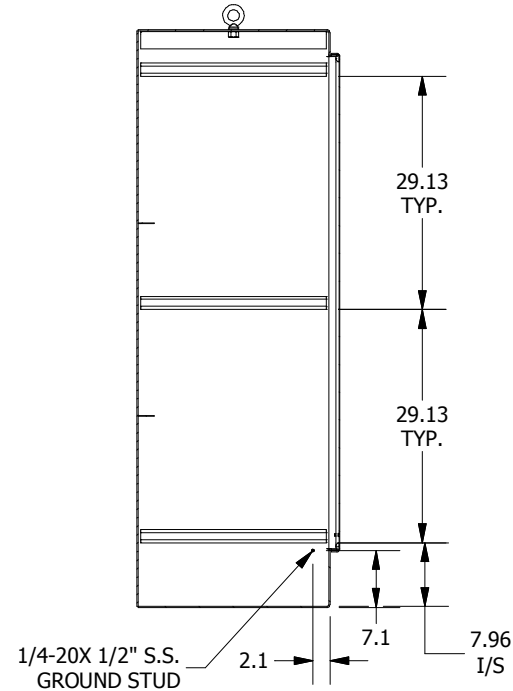

**SECTION B-B
(INSIDE RIGHT OF ENCL.)**

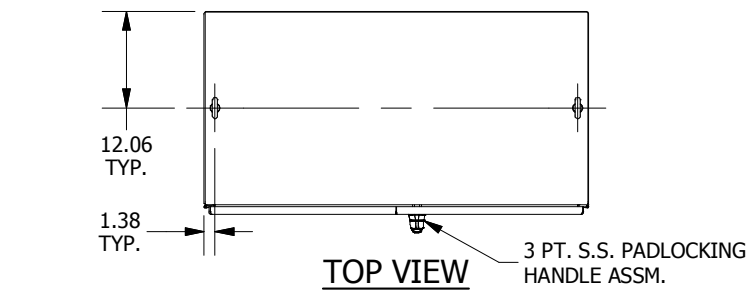

TOP VIEW

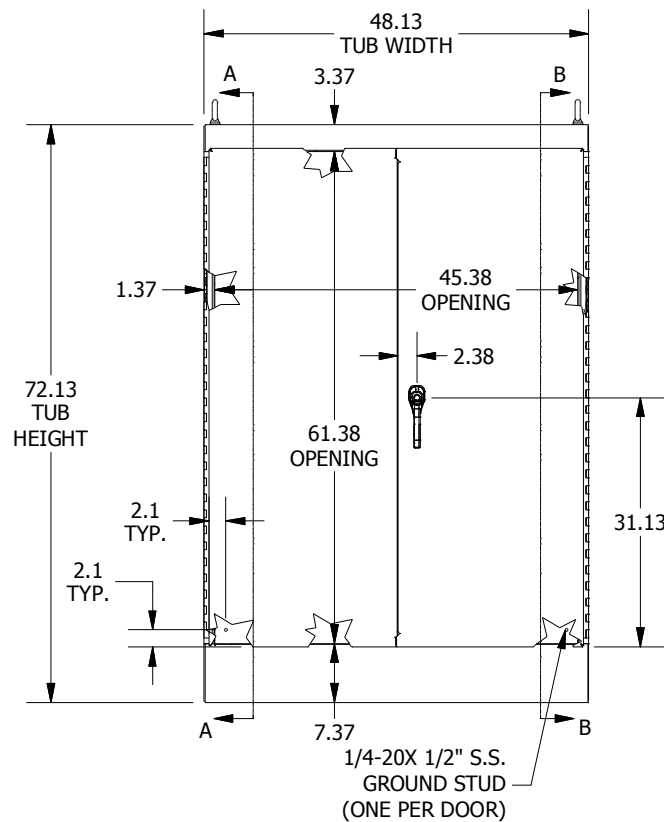

FRONT VIEW

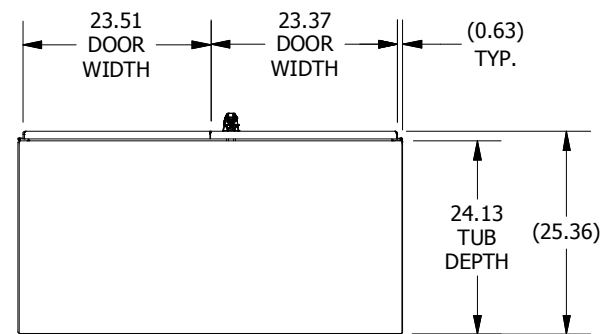

BOTTOM VIEW

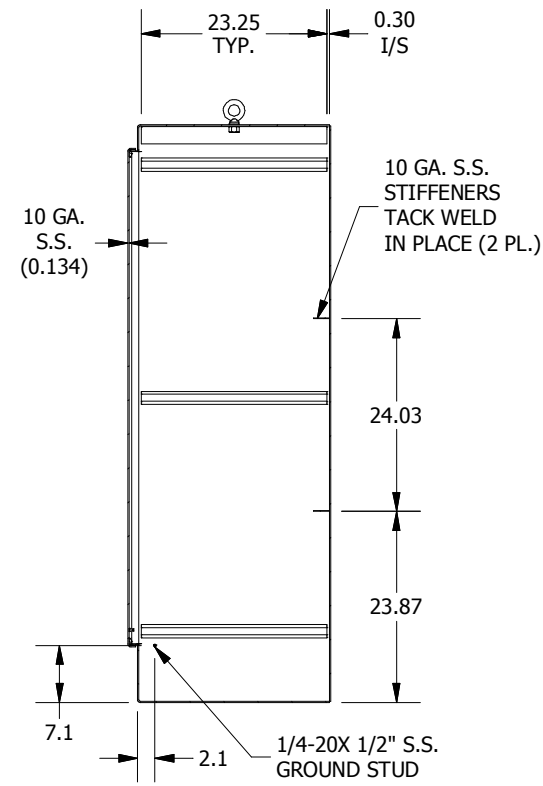

**SECTION A-A
(INSIDE LEFT OF ENCL.)**

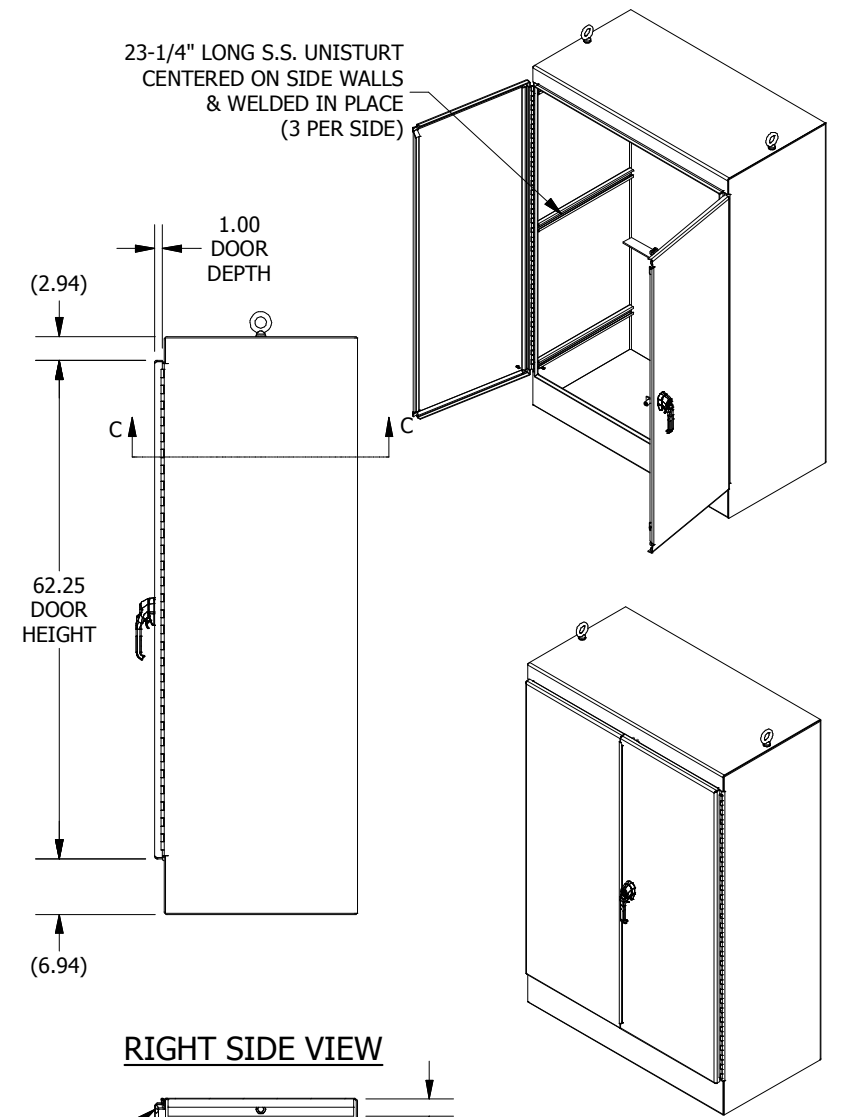

RIGHT SIDE VIEW

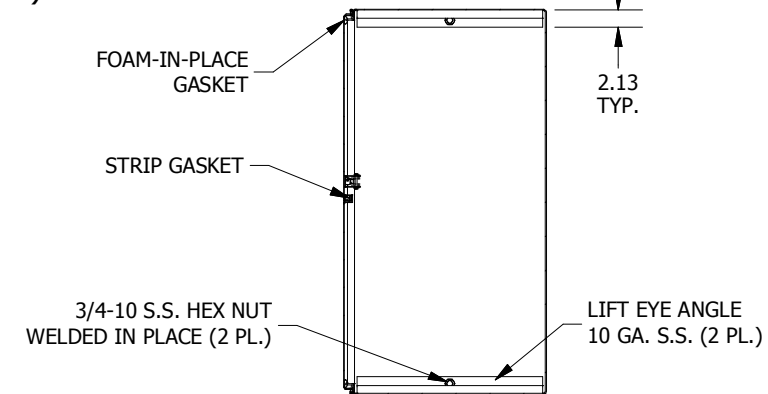

SECTION C-C

PART#: WA724824FSDSS
(DATA SUBJECT TO CHANGE WITHOUT NOTICE)

THIS DRAWING IS PROPERTY OF HUBBELL INC. WIEGMANN
ALL INFORMATION IS PROPRIETARY AND NOT TO BE DUPLICATED