

**TOP VIEW**

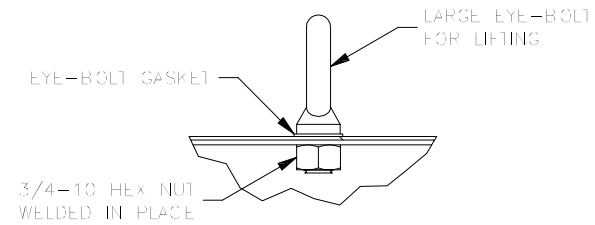

**DETAIL A  
(LIFT EYE DETAIL)  
(TYP.)**

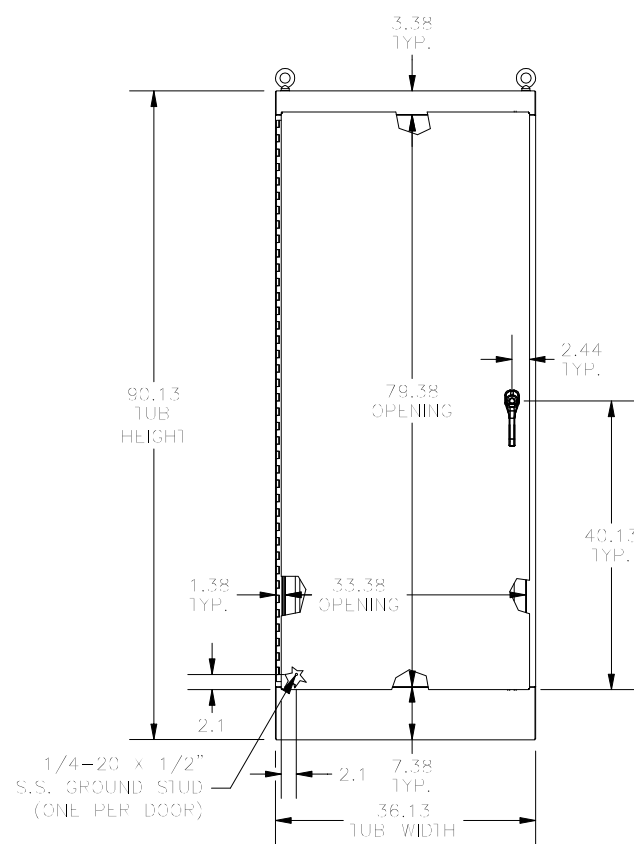
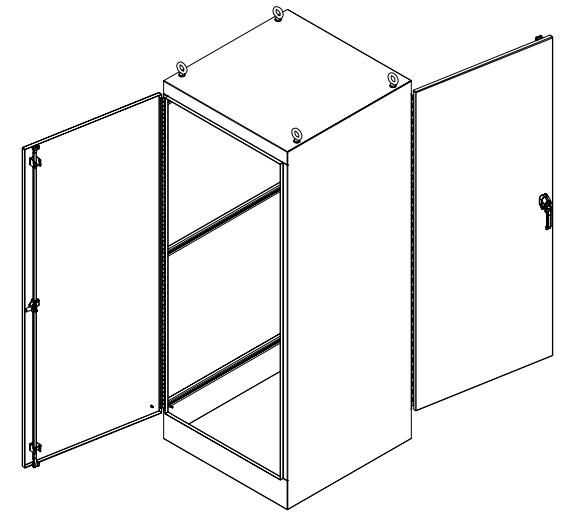

**FRONT VIEW**

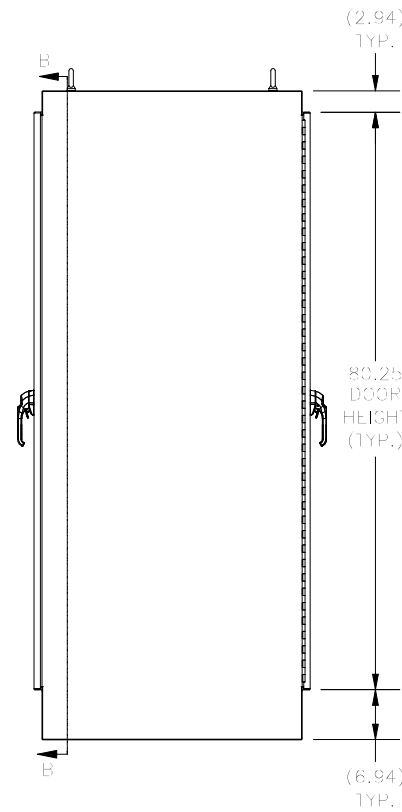

**SIDE VIEW**

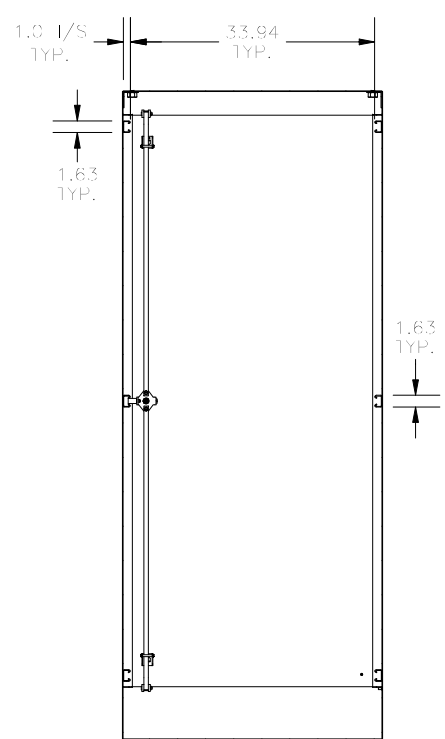

**SECTION B-B  
(INSIDE FRONT/BACK OF ENCL)  
(TYP. FOR BOTH SIDES)**

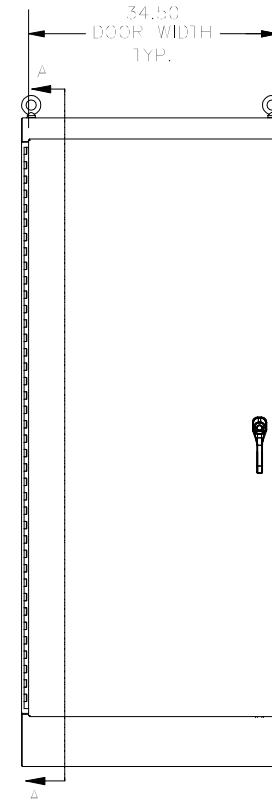

**REAR VIEW**

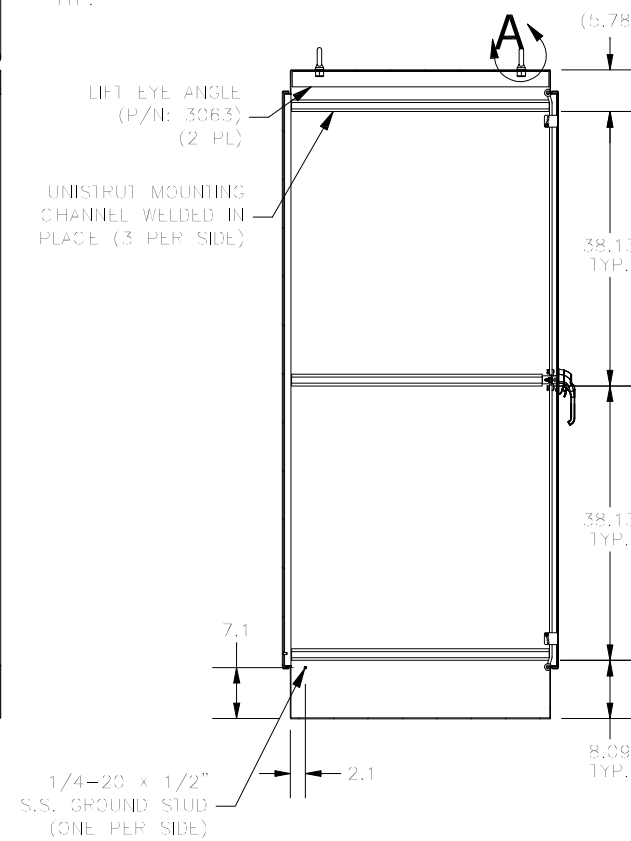

**SECTION A-A  
(INSIDE SIDE OF ENCL.)  
(TYP.)**

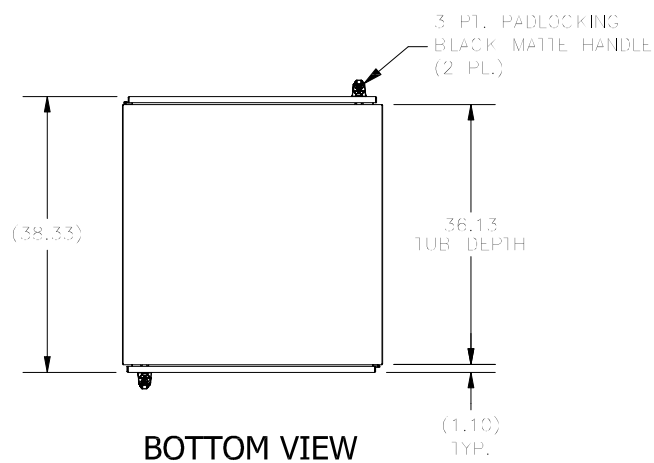
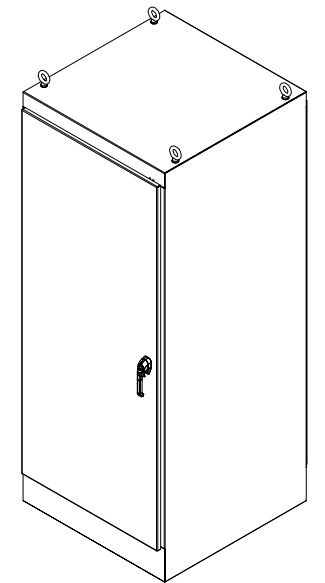

**BOTTOM VIEW**

PART#: WA903636FSDA  
(DATA SUBJECT TO CHANGE WITHOUT NOTICE)

THIS DRAWING IS PROPERTY OF HUBBELL INC. WIEGMANN  
ALL INFORMATION IS PROPRIETARY AND NOT TO BE DUPLICATED